

AGENDA
CRHSAC Planning Subcommittee Agenda (Hybrid)
Tuesday, April 7th, 2026

2:40 PM

CMEMSC

361 Holden Street

Holden, MA 01520

&

<https://us02web.zoom.us/j/85817858831>

- 1. Call To Order**
 - a. Introductions
- 2. Minutes of March 3, 2026**
 - a. Vote to Accept Minutes
- 3. Chair Report:** Chief Kochanowski
- 4. Project Status/Old Business**
- 5. New Business**
 - a. FFY2026 Proposals
 - i. Review proposals that were tabled at prior meeting
 1. Discussion & possible vote
 - ii. Draft FFY26 A list/B list & Budget
 1. Discussion & possible vote
- 6. New Business Unforeseen by the Chair**
- 7. Next Meeting TBD**
- 8. Adjourn**

*This meeting is audio recorded

Minutes
CRHSAC Planning Subcommittee
Tuesday, March 3, 2026 1:45 PM
CMEMSC 361 Holden St. Holden, MA 01520

Members Present: **Dean Kochanowski**, Chair, Fire Chief, Dudley Fire; **Greg Lynskey**, Director, SWCCC; **Gary Fleischer**, Fire Chief, Worcester Fire; **Mike Borowiec**, Lt., Shrewsbury Fire.

Attendees: **Seth Peters**, CMRPC; **Carli Harris**, CMRPC; **Robert Connolly**, Emergency Management Director, Worcester Emergency Management; **Jaymely Castillo**, Worcester Emergency Management; **William Francis**, Communications Manager, Fire District 14; **Chris Baker**, CMEMSC.

Call To Order: Meeting was called to order at 1:48pm by **Chief Kochanowski**.

Introductions: Introductions were done for both in person and virtual attendees.

Minutes: Meeting minutes of February 4, 2025 and March 13, 2025 were presented. Motion by **Lt. Borowiec** to accept the minutes, seconded by **Mr. Lynskey**. **Motion passed unanimously.**

Chair Report: None.

Project Status/ Old Business: None.

New Business:

FFY2026 Proposals: For this portion the council agreed to review all proposed projects first, discussing as needed how to sort them into A/B lists by consensus and then vote on all the proposals in one motion. A/ B list is based on the FFY25 budget of \$834,983.71.

CRHSAC CMRPC Admin Costs:

- Proposed for \$225,500.00
- **Council A listed \$225,500.00 for CMRPC Admin Costs**

Regional Health & Safety Plan Phase III:

- Proposed for \$60,000.00
- Regional all hazards continued planning including evacuation plans and maps.
- **Council B listed Regional Health & Safety Plan Phase III**

FD7 Dive Team Training:

- Proposed for \$10,000.00
- Rapid deployment search and rescue/ recovery training program
- **Council A listed \$10,000.00 for FD7 Dive Team Training**

FD7 Dive Team Equipment:

- Proposed for \$27,130.00
- Rapid deployment/ basic scuba diving equipment for the Mass District 7 Regional Dive Team
- **Council A listed \$27,130.00 for FD7 Dive Team Equipment**

CEMLEC SWAT Night Vision Goggles:

- Proposed for \$323,684.00
- Procurement of 30 night vision devices with mounts and battery packs for the CEMLEC SWAT team
- **Council B listed pending discussion next month**

CMEMSC Tri-Band Radios:

- Proposed for \$50,429.70
- 3 response vehicles currently equipped with UHF only portable radio capabilities and need to be updated to comply with CoMIRS P25 phase 2 standards
- **Council A listed with interim solution \$50,429.70 for CMEMSC Tri-Band Radios**

FD7 Swiftwater Training (ITRA Bridge Program):

- Proposed for \$6,900.00
- This program will bridge previous training with the International Technical Rescue Association level I/II standard as well as FEMA Water Rescue Specialist standard
- **Council A listed \$6,900.00 for FD7 Swiftwater Training (ITRA Bridge Program)**

FD7 Swiftwater Training (Boat Operator Training):

- Proposed for \$9,800.00
- ITRA Swiftwater Boat Operator and FEMA 509 Boat Operator training to train and certify up to 12 members as Swiftwater Boat Operators
- **Council A listed \$9,800.00 for FD7 Swiftwater Training (Boat Operator Training)**

Fitchburg Regional Barricades:

- Proposed for \$130,100.97
- Regional moveable barricades to mitigate vehicle hostile threat at polling locations, special events and mass gatherings
- **Council B listed with recommendation for Chief Haverty and Rob Connolly to discuss a possible regional project/ brands**

Regional K9 Unit (Millbury):

- Proposed for \$86,628.50
- Purchase of a vehicle dedicated to both local operations and regional responses through the CEMLEC K9 Unit to support the continued sustainability of the Firearms Detection, Tracking, and Patrol K9 Program serving Central Mass
- **Council decided to not accept this proposal due to the discussion that they will only replace K9 vehicles that were previously purchased using Homeland funding.**

Regional Heating Units:

- Proposed for \$10,000.00
- To service/refurbish the regional portable heating trailer cache of heating units and generators following a dramatic winter season and to support training to properly service these units in house
- **Council A listed \$10,000.00 for Regional Heating Units**

Worcester County Sheriff's Mobile Command Unit (New):

- Proposed for \$760,463.00
- Purchase of a new mobile command center

- Council decided not to accept this project due to funding limitations

Worcester County Sheriff's Mobile Command Unit (Refurbished):

- Proposed for \$358,424.00
- Upgrade of current mobile command unit
- **Council initially declined this project, but then tabled it for next meeting**

D7 Swiftwater Rescue (PPE):

- Proposed for \$20,050.00
- Purchase and deployment of 10 complete Swiftwater Rescue PPE operational kits
- **Council A listed \$20,050.00 for D7 Swiftwater Rescue**

Worcester EM Moveable Barriers Phase II:

- Proposed for \$160,172.92
- Purchase of 20ft mobile wedge barriers (DSC MP5000) for Phase 2 of the Moveable Bollard project
- **Council B listed with recommendation for Chief Haverty and Rob Connolly to discuss a possible regional project/ brands**

Regional K9 Unit (Worcester):

- Proposed for \$146,388.00
- Procurement of two police cruisers to support the Worcester Police Department's Explosive Ordnance Detection (EOD) K-9 Teams
- **Council A listed only 1 vehicle \$73,194.00 for Regional K9 Unit**

Uxbridge PD Mobile Command Post/ Patrol Vehicle:

- Proposed for \$18,500.00
- Purchase and installation of a rack system into a patrol vehicle to function as a mobile command post. A multi-jurisdictional P-25 dual band radio will be installed in the rack system as well as a mobile command board to facilitate command and control
- **The council did not approve this project because it did not seem like a regional asset**

Hudson FD14 Vehicle Replacement:

- Proposed for \$61,476.60
- The total cost of replacing Car 14 and the required equipment is \$312,086. The breakdown of Fire District 14 communities is about NERAC 72% and CRHSAC 28%
- **Council A listed \$61,476.60 for Hudson FD14 Vehicle Replacement**

Douglas Aggressive Command Training:

- Proposed for \$28,500.00
- Funding for Aggressive Incident Command training
- **Council B listed training due to upcoming Aggressive Incident Command trainings**

Bolton Fire- Hostile Threat/ Public Gathering Resource Trailer:

- Proposed for \$217,400.00
- Outfit a field operations trailer for local agencies to include dispatch, traffic control, crowd monitoring, planning, and staging supplies
- **Council B listed pending discussion next month**

Central Region TRT Equipment:

- Proposed for \$86,000.00

- Region 3 Technical Rescue Equipment - All fire district TRTs in Central MA included
- **Council A listed \$86,000.00 for Central Region TRT Equipment**
- Central Region D7 TRT Prime Mover:
 - Proposed for \$122,000.00
 - A goose neck trailer that can accommodate a higher GVW and the full cache of structural response equipment was donated to D7. This trailer however needs a vehicle equipped to tow the vehicle appropriately and safely
 - **Council A listed \$122,000.00 for Central Region D7 TRT Prime Mover**
- QCC- Worcester Colleges Regional Message Board Trailer:
 - Proposed for \$16,867.00
 - The college is looking to be the host site of a trailer sign board available for community notification, emergency management use, and regional deployment
 - **Council B listed this project**
- Placeholder for CEMLEC Equipment
 - Discussed by the council to put placeholder for law enforcement/ CEMLEC equipment
 - Put aside \$108,876.41
 - **Council A listed \$108,876.41 for potential projects for law enforcement/ CEMLEC equipment**

Motion to approve the A and B draft list for FFY2026 made by **Mr. Lynskey**, seconded by **Chief Fleischer**. **Motion to approve the draft A and B list for FFY2026 passed unanimously.**

CMRPC Report: None.

New Business Unforeseen by the Chair: None.

Next Meeting: TBD

Adjourn: **Mr. Lynskey** made a motion to **adjourn the meeting**, seconded by **Chief Fleischer**. **Motion to adjourn passes unanimously. Meeting adjourned at 2:50pm.**

Minutes taken by Carli Harris.

Minutes approved by the Planning Subcommittee on _____.

FFY2026 PROJECT PROPOSAL

For the CRHSAC FFY2026 SHSP INVESTMENT PLAN

Please complete this form and return it to crhsac@cmrpc.org no later than **Friday, February 27, 2026.**

Proposed Project Name:

Proponent Name and Contact information:

Proposed Activity: Hostile threat/ public gathering resource trailer

Location Bolton

Project Need: Outfit a field operations trailer for local agencies to include dispatch, traffic control, crowd monitoring, planning, staging supplies.

Measurable Outcomes:

Background

Describe regional benefit and/or participants: The Central Massachusetts area is a very active area of the commonwealth. Many large gatherings occur on an annual basis including but not limited to sporting events, local festivals and political gatherings. Local first responders lack the central resource platform to perform the most efficient operation. The addition of an trailer capable of storing most commonly used safety equipment will enhance that safety for the general public. The trailer is a package bought trailer that includes installed tables and work stations for a dedicated dispatcher at an event or hostile event. Climate control to keep operators comfortable and able to focus on their job during an event. Onboard generator to supply power to communications and lighting and storage of rehab supplies. In addition, we plan to build out the trailer to accommodate the storage of an inflatable tent and heater, traffic cone storage of one hundred traffic cones, raid deploy barricades, drones, and portable radios.

While the trailer will have the ability to handle large crowd events it will also be able to deploy to hostile threat events. The trailer will be positioned in the staging area to allow for a more visual landmark for arriving mutual aid. Rapid deployment of radios, ballistic vests and helmets and rapid taskforce supplies to include medical bags, patient litters. Each bag and ballistic outfit will be standardized with the same equipment for increased responder efficiency. Radios will be available for seamless operational integration. Traffic safety supplies including traffic cones, barricades can be removed from the trailer and deployed to other areas from the poly box system. Cones will be colored to signify different working areas and have the flexibility to be setup reunification areas, evacuation areas as well as barricading off areas during the event.

This resource will assist area department in centralizing the supplies needed to respond to events with large crowds and quickly deploy during hostile threat events. The lack of manpower to deploy the resources is decreased to a small number of responders. Bolton is centrally located to Fire Districts six, seven, eight and fourteen and would be able to deliver the trailer along with members that would be able to setup the trailer including FAA certified drone pilots that can assist with deployment and tracking of equipment during an event.

Is your community/organization NIMS compliant? The Town of Bolton is NIMS compliant

Have any community and/or organization funds already been allocated for this project? No funding has been planned or approved for this project at this time.

Are there other funding sources available for this project?

If awarded, please explain plans for sustaining this project:

Budget Plan by Cost Category:

Planning	\$
Equipment	215,000\$
Training	2000\$
Exercises	\$
Maintenance	400 \$
Organization	\$
Total	217400\$

Please attach any additional documentation for back-up. Price quotes or cost estimates are appreciated.

<https://www.totaltrailers.com/unit/24-command-response-trailer-w-generator-630060>

<https://www.efjohnson.com/viking-vp8000-portable-radio>

https://safetysuppliesusa.com/products/100-pack-28-orange-traffic-cone-7lb-black-base-w-6-4-retroreflective-collars-mutcd-compliant-copy?currency=USD&variant=50028456476919&stkn=b192354018e9&utm_source=google&utm_medium=cpc&utm_campaign=23587916347&utm_content=188645393890&utm_term=&gad_source=1&gad_campaignid=23587916347&gbraid=0AAAAA-dS6MD45qt7Yph8x666jnawyNle8&gclid=CjwKCAiAnoXNBhAZEiwAnItcGw gw2-T09jGgie_37IgPOMMNvQ7ivC4iqeQlxl pSZIZUxES8KzOYgRoCFzYQAvD_BwE

<https://www.skydio.com/x10>

<https://propacusa.com/product-category/inflatables/small-tent>

FFY2026 PROJECT PROPOSAL

For the CRHSAC FFY2026 SHSP INVESTMENT PLAN

Please complete this form and return it to crhsac@cmrpc.org no later than **Friday, February 27, 2026.**

Proposed Project Name: CEMLEC SWAT NIGHT VISION

Proponent Name and Contact information:

Deputy Commander Keith Taparausky

Worcester County Sheriff's Office

5 Paul X Tivnan Dr

West Boylston, MA

Ktaparausky@sdw.state.ma.us

508-854-1800

Proposed Activity: This project will procure thirty (30) Night Vision Devices with mounts and battery packs for the Central Massachusetts Law Enforcement Council (CEMLEC) SWAT team. This equipment is essential to sustain the SWAT team's anti-terrorism capabilities in the Central region.

Project Need: This project would bring the equipment the team needs to function at night up to modern standards. The night vision devices are needed in order to allow the CEMLEC SWAT team to maintain all-weather and all-aspect capability to deploy at any hour. There are many instances where time is of the essence, in a hostage scenario for example, and being forced to wait until daybreak would put both team personnel as well as civilians in unnecessary risk. CEMLEC SWAT is one of the few Teams in the state that does not have this vital piece of equipment. And interoperability with other SWAT Teams such as METRO SWAT which our Team shares security and counter terrorism responsibilities at Gillette Stadium for all events to include the World Cup this year. In 2013 both our Teams worked together at the Marathon bombing and man hunt and it is imperative this request gets put forward, and in a timely manner. The costs of this equipment are orders of magnitude past what the LEC is able to provide with its own operating budget

Measurable Outcomes: The equipment procured under this project will allow the CEMLEC SWAT team to train for and deploy to dangerous situations to effectively respond to threats such as a barricaded subject, active shooter, and other similar terror related incidents. Sustaining this anti-terrorism capability is key to protecting the Central region. This project will allow the team to perform at a high standard as they have done in the past in high-risk situations. And have interoperability with other Teams when the need arises.

Background (e.g.: continuation of previous project, funding limitations, etc.): The Central Massachusetts LECs have increasingly been working together over many past federal funding years fulfilling training and exercise investments, cooperative procurements, and tactical gear. The LECs have worked consistently to

assist the Councils to build up the following capabilities: unarmed barricaded persons, armed barricaded persons, hostage situations, high risk search warrants and other life-threatening incidents.

Describe regional benefit and/or participants: *CEMLEC SWAT Team is a regional Team that covers over 62 cities and towns in the Central Region. This piece of equipment will bring the Team up to modern standards to help aid not only the Team but the region in which it covers to be better prepared to serve and protect.*

Is your community/organization NIMS compliant? Yes

Have any community and/or organization funds already been allocated for this project?
No

Are there other funding sources available for this project? No

If awarded, please explain plans for sustaining this project: *CEMLEC SWAT will incur all maintenance and up keep costs to the equipment such as battery replacement.*

Budget Plan by Cost Category:

Planning	\$
Equipment	\$232,684.20
Training	\$
Exercises	\$
Maintenance	\$
Organization	\$
Total	\$232,684.20

Please attach any additional documentation for back-up. Price quotes or cost estimates are appreciated



USIQ Inc.
 3150 Commercial Ave
 Northbrook, IL 60062
 Phone: 1-888-882-8747
 Email: volumesales@usiq.com

Quotation

QUOTATION #	DATE	CUSTOMER ID	REFERENCE #
117640	2/24/2026	10870925	0



SELL TO
Keith Taparausky Worcester County Sheriff's Office 240 Maint St Worcester MA 01608 United States

SHIP TO
Keith Taparausky Worcester County Sheriff's Office 5 Paul Tivnan Dr West Boylston MA 01583 United States

Shipping Method:	Value Shipping	Payment Method:		Last 4 digits:	
Freight Terms:		Payment Terms:		PO Number:	
Delivery Information:	22 UNITS AVAILABLE	Offer Valid for:	30 days		
Sales Person:	Rafael Maldonado	All prices are in US dollars.			

SKU	DESCRIPTION	QUANTITY	TOTAL WEIGHT	UNIT PRICE	TOTAL
0A-NVG-NBD2-NSGNYX15M4G9DU2	Armasight BNVD-40 Night Vision Goggles, White Phosphor - 2200 FOM Min w/ Battery Pack, Gray, NSGNYX15M4G9DU2	30	120	\$7,575.76	\$227,272.80
				SUBTOTAL	\$227,272.80
				SHIPPING	\$0.00
				SALES TAX	\$0.00
				TOTAL	\$227,272.80

All quotes valid for seven (7) days from date of issuance. Quotes are provided based on currently available manufacturer price lists and are subject to change due to the impact of global tariffs. All prices are shown in US Dollars.

If you have any questions concerning this quotation, contact our Sales Team via e-mail to volumesales@usiq.com or via phone 1-888-882-8747, Monday - Friday 8 AM to 6 PM CST.

Please see <https://usiq.com/our-policy/> for our Policies.

Important Export Restrictions: Commodities, products, technologies, and services listed herein are subject to one or more of the U.S. export control laws and regulations enforced by the U.S. Department of State, the U.S. Department of Commerce, or the U.S. Department of the Treasury. It is unlawful and strictly prohibited to engage in conduct requiring a license or other approval from the proper U.S. Department without such license or approval. Such conduct includes, but is not limited to, the export, or attempt to export or otherwise transfer or sell any commodity, product or technical data, or furnishing any service to any foreign party, whether abroad or in the United States. Furthermore, U.S. law prohibits the sale, transfer, or export of items to Embargoed Countries and entities on the Department of State's List of Debarred Parties, the Department of Commerce's Denied Persons List, and the Department of the Treasury's Specially Designated Nationals and Blocked Persons List. It is the Buyer's responsibility to be aware of the Lists of Embargoed Countries, Debarred Parties, Denied Persons, and Specially Designated Nationals and Blocked Persons. These Lists can be found at the applicable U.S. Government agency website.

Having lawfully received the above commodities, the Buyer and Entity and/or Person(s) listed in Ship To (1) assumes all responsibility to further comply with the requirements imposed by all applicable laws, regulations and administrative policies and (2) certifies that it will so comply. Diversion contrary to U.S. law is prohibited.

The export control laws and regulations are complex; therefore any summary of such laws and regulations herein is not comprehensive and is not to be taken as legal advice or counseling.

All Exports: These commodities, technology or software were exported from the United States in accordance with the Export Administration Regulations. Diversion contrary to United States law is prohibited.



US|NIGHT VISION

1420 E. Roseville Pkwy.
Suite 140-321
Roseville, CA 95661

Quotation

Quote Expires	Quote Date	Estimate #
3/12/2026	2/12/2026	11234

Name / Address
CEMLEC SWAT 5 Paul X Tinvan Dr West Baylston, MA 01583

Ship To
CEMLEC SWAT 5 Paul X Tinvan Dr West Baylston, MA 01583

Terms	Rep
TBD	DG

Qty	Item	Description	Price	Total
30	4061235	NVG-ALPHA Dual Tube Articulating Night Vision Goggle - Full Spec White Phosphor / Black Housing, Digital Manual, Data Sheets, Sac Window (2), Demist Shield (2), Lanyard, Lanyard Rings, 3VBattery (1).	7,327.30	219,819.00T
30	ALPHA-MOUNT	Nocturn Industries ALPHA Dovetail Helmet Mount	423.84	12,715.20T
1	Shipping	Shipping & Insurance	150.00	150.00
		Lead Time: 2 Weeks ARO NET 30 Accepted w/PO		

Subtotal	\$232,684.20
Sales Tax (0.0%)	\$0.00
Total	\$232,684.20

FFY2026 PROJECT PROPOSAL

Proposed Project Name: FFY2026 Regional Movable Barricades

Proponent Name and Contact information: Patrick Haverty, Assistant Fire Chief/Emergency Management Director, City of Fitchburg
phaverty@fitchburgma.gov
978-345-9663

Proposed Activity:

To purchase 1 mobile trailer package with movable barricades, chains, gates, signs etc... For regional use during elections, special events, and mass gatherings.

Project Need:

The region needs assets to effectively mitigate the Hostile Vehicle Incident (HVI) threat. This equipment will allow barriers to be deployed at the perimeter of polling locations, streets, special events, or other Mass gatherings.

Measurable Outcomes:

We will measure the effectiveness of this project by tracking the number of deployments throughout the region, the number of municipalities PD/FD/DPW/EM departments being trained on deploying the assets. Additionally, after deployments we will request feedback from the municipality on how the asset improved security of the event. Finally, in the event of a HVI or accidental vehicle incident occurs – we can analyze the effectiveness of the barricades as compared to how the incident may have occurred with out safety barricades in place.

Background (e.g.: continuation of previous project, funding limitations, etc.):

Vehicle Ramming Attacks or Hostile Incidents have been increasing in occurrences globally. Violent extremists and Foreign Terrorist Organizations are increasingly encouraging these attacks, as well as disseminating videos and articles on planning and executing these attacks. Polling locations around the region typically have long lines, exposing voters and election workers to vehicle ramming attacks. In the North Central Mass area alone, there are numerous Special events that attract over 10,000 people from all over the district requiring a multitude of streets to be blocked to prevent HVI's. Saw horses and hay bails do not provide adequate security and the amount of backhoes, dump trucks and other vehicles to block the roads are hard to come by and cost prohibitive to provide.

Not only are there numerous festivals and events in Fitchburg that require protection from HVI, but in the neighboring cities and towns in North Central Mass there are additional festivals requiring the same road security, Unprotected polling locations and University Graduations.

These barricades will be part of many multiple -jurisdictional Emergency Action plans. As of right now road security and blockages have been included in these EAP's already. The non-availability of these type of blockades. Have caused an exasperation of resources. From Saw-horses and hay bales (that do not provide adequate protection) to DPW vehicles (Backhoes and Dump trucks) that are not enough and are not cost effective to deploy.

All possible other means of funding will be investigated to continue to acquire a cache of equipment to provide adequate security to all regional partners.

If we are awarded this grant. Fitchburg Emergency Management plans to keep this equipment stored and ready to deploy if any of our regional partners need assistance.

Budget Plan by Cost Category:

Planning	\$
Equipment	130,100.97
Training	\$
Exercises	\$
Maintenance	\$
Organization	\$
Total	130,100.97

Please attach any additional documentation for back-up. Price quotes or cost estimates are appreciated.

Attached;

Quote for the barricade system

Example of 1 event this would be used for in the region, supporting the need for this project.

- A) Road Closure list for the event
- B) Picture showing an example of the vulnerability of citizens at risk
- C) Information on the barricade system

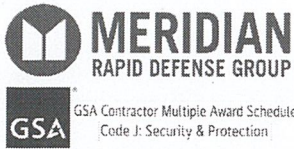

Meridian Rapid Defense Group Sales LLC
 177 E. Colorado Blvd
 Suite 200
 Pasadena CA 91105
 United States

Quote

#QUO-S-10842

GSA Contract #47QSWA19D001F

02/19/2026

Bill To
 City of Fitchburg
 Patrick Haverty
 33 North Street
 Fitchburg MA 01420
 United States

Ship To
 City of Fitchburg
 Patrick Haverty
 33 North Street
 Fitchburg MA 01420
 United States

Date	Expires	Shipping Method	Sales Rep
02/19/2026	05/17/2026	Freight Out	Will . Landale

Item	Price Level	Quantity	Rate	Amount
TRLKIT1000		1	0.00	
T1000	GSA	1	34,247.85	\$34,247.85
AB1200	GSA	8	6,513.75	\$52,110.00
AMHA003-2	GSA	1	1,925.18	\$1,925.18
AFTB001	GSA	2	574.18	\$1,148.36
AACN4F022	GSA	7	574.18	\$4,019.26
RG	GSA	1	12,540.18	\$12,540.18
INACTIVE - AMB1200	GSA	1	5,785.18	\$5,785.18
AMB1200WS	GSA	8	0.00	
WF3C	GSA	8	0.00	
WF4PTO	GSA	8	0.00	
WF2STP	GSA	8	0.00	
WF1RC	GSA	8	0.00	
ACP001ADA	GSA	7	574.18	\$4,019.26
End of Group			0.00	\$115,795.27
Inactive - AGP001	GSA	8	56.94	\$455.52
MCTR002	GSA	1	3,855.18	\$3,855.18
F		1	9,995.00	\$9,995.00

Subtotal	\$130,100.97
Tax (0%)	\$0.00
Total	\$130,100.97



QUO-S-10842

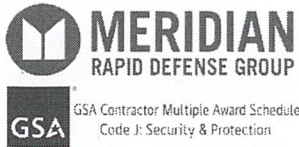

Meridian Rapid Defense Group Sales LLC
177 E. Colorado Blvd
Suite 200
Pasadena CA 91105
United States

Quote

#QUO-S-10842

02/19/2026

GSA Contract #47QSWA19D001F

Notes:

Payment Terms:

Due to high demand, Meridian is requesting a 50% deposit to ensure timely delivery of your product.

Wire Transfer Instructions:

Meridian Rapid Defense Group Sales LLC

Account Number: 568605235

Bank Name: Chase Bank, N.A.

Wire Routing : 021000021

ACH Routing : 322271627

Check Remittance:

530 New Los Angeles Ave #115-345

Moorpark, CA 93021



QUO-S-10842

Archer® 1200 Barrier

1. Modular barrier
Expandable footprint
Compatible with all Meridian products

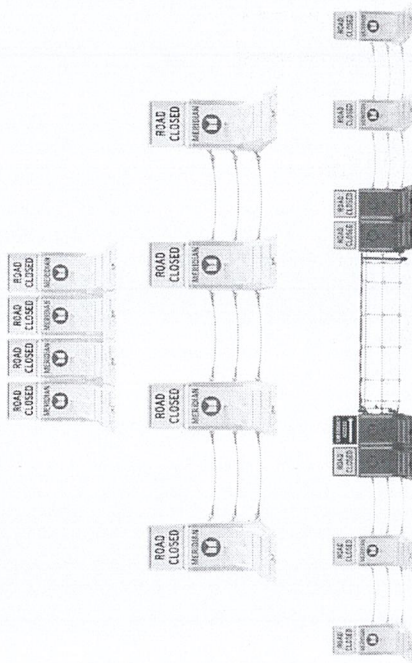

2. Over **20** certified configurations
The most crash tested mobile vehicle barrier in the world
Reusable after impact



3

- No hydraulic
- No electricity
- No forklifts
- One person deployment
- Maintenance free
- Lifetime warranty

Scan to see the
Archer® 1200
barrier in action.



WE OFFER RENTAL AND PURCHASING OPTIONS! GIVE US A CALL TO DISCUSS YOUR NEEDS (434) 529-6903



MERIDIAN
RAPID DEFENSE GROUP



Archer® 1200 Barrier Specifications

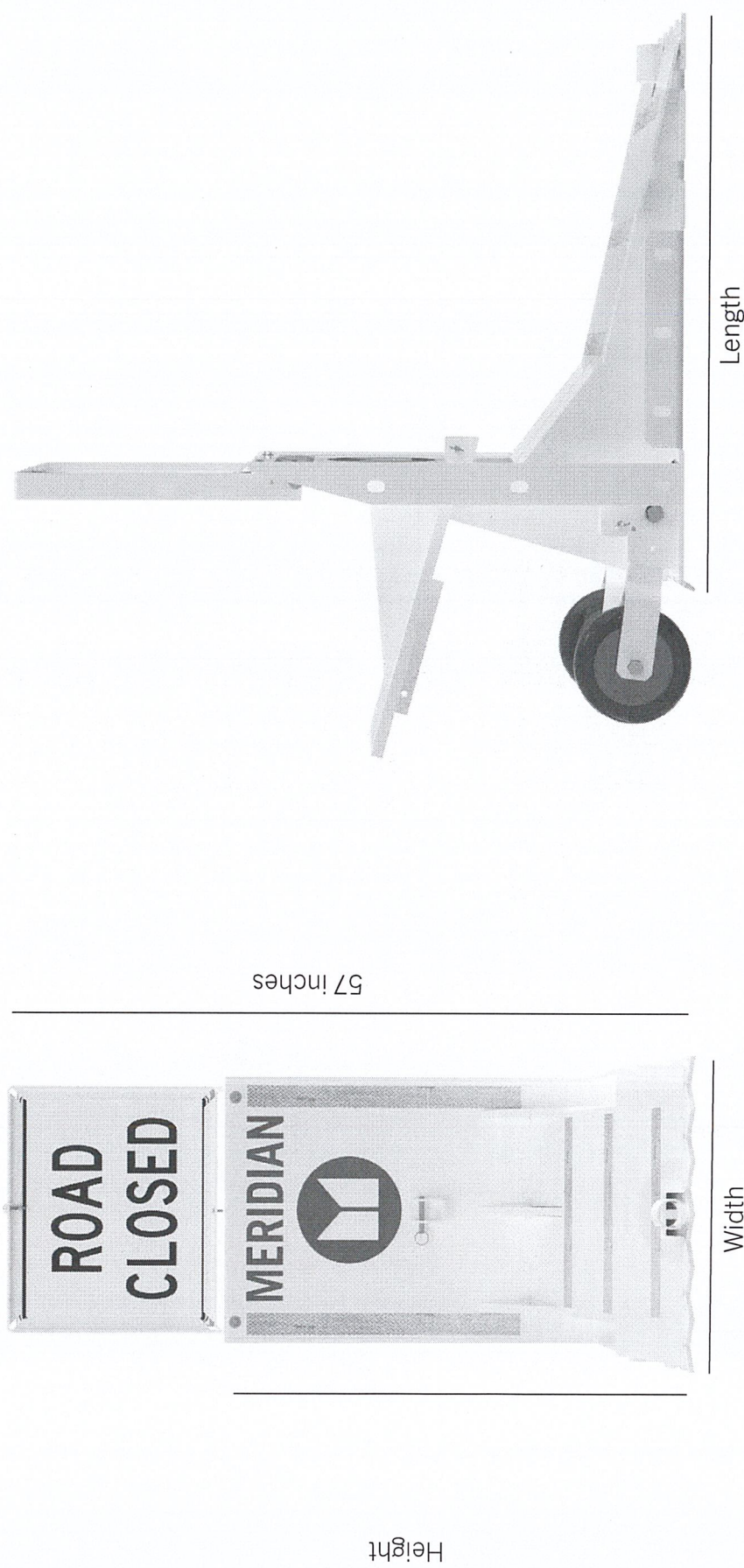

57 inches

Length

56 inches

Archer® 1200 Barrier Dimensions

- Length- 48 in
- Width- 24 in
- Height- 36 in
- Weight- 680 lbs.
- Surface Area- 11288 square in
- Material- ASTM A36 Steel/AR500
- Length with the wheels down- 56 in
- Height with the Wayfinding Frame- 57 in

Archer® 1200 Barrier Features

- Allows for one-person deployment of an 8 barrier trailer kit in under 10 minutes.
- Full ballistic protection for any armor piercing 50 caliber rounds.
- Archer Hauler allows for easy movement of barriers by adults of any stature.
- Permits pedestrian and emergency vehicle access without moving a barrier.

Archer® Rapid Gate

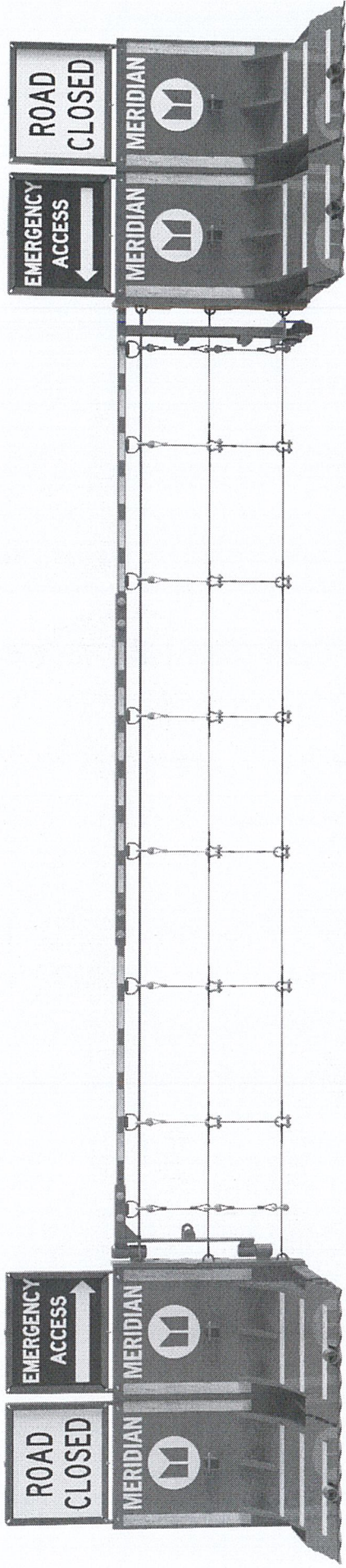

FEATURES

- Expandable to 10ft, 12ft, and 14ft
- Fast to assemble
- Ideal for road closures
- Great for construction sites
- Crash certified ASTM P2 rating!
- #1 emergency access gate

MUTCD

The Archer® Rapid Gate is designed to be visible on roads by using bright Traffic Orange paint and HIP reflective decals. The directional signage is all MUTCD approved.

180 Degree Horizontal Rotation

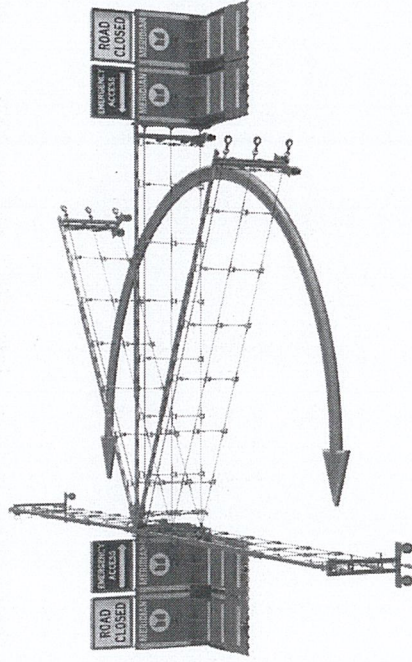

WE OFFER RENTAL AND PURCHASING OPTIONS! GIVE US A CALL TO DISCUSS YOUR NEEDS (434) 529-6903



MERIDIAN®
RAPID DEFENSE GROUP



FFY2026 PROJECT PROPOSAL

For the CRHSAC FFY2026 SHSP INVESTMENT PLAN

Please complete this form and return it to crhsac@cmrpc.org no later than **Friday, February 27, 2026.**

Proposed Project Name: Modernize Mobile Command

Proponent Name and Contact Information:

Sergeant Paul Salvadore
Direct Line (508) 854-1916
Mobile (508) 599-0221
Email psalvadore@sdw.state.ma.us

Proposed Activity: To remove all outdated equipment and replace it with current equipment.

Location (If proposed activity is a training): N/A

Project Need: The mobile command has many analog systems with outdated technology. The updates will bring more capabilities

Measurable Outcomes: To better serve the cities and towns, improve interoperability. To move from analog to digital with a better

Background: The current Command Unit is over twenty years old. With much of the technology being outdated. Approximately five years ago, the council purchased six base radios and portables for the command center. The sheriff's department has maintained the command center in proper running condition. It is utilized for both operational and community-based needs. The approximately annual cost of routine maintenance for the truck is currently \$5,000.00. The generator has been replaced once already.

Describe regional benefit and/or participants: The mobile command is available to every city and town in the county, including the CEMLEC SWAT communities. Both for operational functions and community-based events, when requested by any public safety agency. In recent years, the Sheriff's Department has begun working with the Massachusetts Emergency Management Agency (MEMA). We are always striving to make the mobile command unit a more

Is your community/organization NIMS compliant? YES

Have any community and/or organization funds already been allocated for this project? NO

Are there other funding sources available for this project? NO

If awarded, please explain plans for sustaining this project:

Budget Plan by Cost Category:

Planning		\$
Equipment		\$
Training		\$
Exercises		\$
Maintenance		\$
Organization		\$
Total		\$

Please attach any additional documentation for back-up. Price quotes or cost estimates are appreciated.



QUOTATION

Phone: 508-459-0300
www.acceleratedmt.com

Accelerated Media Technologies, Inc
19 Technology Drive
Auburn, MA 01501



Customer: Worcester County Sheriff

5 Paul X. Tivnan Drive
West Boylston MA 01583
Paul Salvatore

Quote Number: 9583 Rev-3

Grand Total \$358,424

Date: 2/26/2026 Quote Valid until: 4/19/2026

Description: Modernize Existing Command Center

**Estimated:
Delivery:** 120 days ARO Typical

Chassis: Wolf 22' Box Truck

Payment Terms: Per State Terms

Taxes Prices quoted are exclusive of all applicable taxes, duties, and insurance, title and registration fees.

Acceptance Point: Auburn, Ma **FOB:** Auburn, Ma

Final Accept: Unless otherwise specifically stated, we request that final acceptance testing take place at our facility in Auburn, MA. Irrespective of acceptance location, customer signature at final acceptance constitutes acknowledgment that items delivered comply with specifications. Latent or hidden defects are covered under our warranty statement, attached.

Warranty: See Attachment:

Attachments: Specifications, equipment summary and layout drawing. Where details do not exist, the default will be to standard Accelerated Media's design and manufacturing processes.

Approvals: _____
Salesman *President/CEO*

_____ *Customer* _____ *Date* _____ *PO#*

This proposal supersedes any and all previous proposals / requests for proposal, and documents included herein govern unless otherwise stated. If an item is not included as part of this proposal, then its inclusion is not implied. Out-of-scope changes will be negotiated for price and schedule impact prior to execution.





19 Technology Drive
 Auburn, MA 01501



Phone: 508-459-0300

Statement of Work

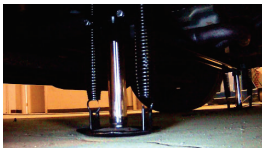

Modernize Existing Command Center

Quantity	Manufacturer	Model	Nomenclature
----------	--------------	-------	--------------

200 Exterior Modifications

1	AMT	AFS-200-06-BF-2	<p>Heavy Duty Jack System (2)</p> <p>System consists of: (2) (Power-Extend/SpringRetract) Jacks with a lifting capacity of 17,000 lbs. per jack. Manual operation feature. All-up & Ignition safety feature. Emergency Retract operation. Lifetime warranty on cylinders. Central & Quad Pump Formats.</p>
			
1	AMT	AFS-200-100-22-P/F	<p>Paint and Finish</p> <p>The body will be sanded and chemically etched and primed with an extreme duty Dupont Primer for maximum adhesion and corrosion protection. Finally the body will undergo a Dupont Gold paint process for maximum durability. Body seams will be treated with seam sealer.</p>
			
1	AMT	AFS-200-15-M21	<p>Awning 21'</p> <p>Our 21' Awning uses only the most reliable, proven and trusted components. Lateral arms provide great headroom, avoid interfering with windows, doors and hatches, and don't block your RV's graphics. Extension and retraction is as easy as pushing a button from the interior control panel or optional remote control. The awning locks automatically when retracted, and the durable case protects your canopy from the elements and road grime.</p>
			

500 Transmission Support

1	AMT	ASP-500-09-HD	<p>Mast Flood Light System</p> <p>In addition to CalOsha requirements, the mast is also equipped with a 12V Flood to illuminate the area over the mast.</p>
			
1	AMT	ASP-500-10	<p>Nycoil Assembly</p> <p>A Black 1.25" ID Recoilable Nycoil will be pulled with the required cables. Cable compliment will be approved by customer prior to pulling. Low Profile brackets will be provided to hold the Aimer,</p>
			

Quantity Manufacturer Model

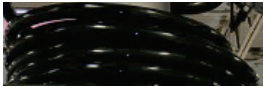

Nomenclature

MastCam and Off Air Antenna. Black Nycoils have the highest level of UV resistance and have proven to be the most durable over time.

Old Nycoil will be REMOVED and upgraded to include advanced prep for future drone technologies:

To Include: Network Cables, AC and Green Strobe.

1 AMT ATR-500-03-RB-RR



Rebuild Mast Remove and Reinstall

Mast Rebuild:

Includes mast removal, disassembly, chemical wash, replacement of all seals and expanders and reassembly. The system will be fully tested.

This service is designed to rebuild a mast in a rebuildable condition. Masts with bad sections or collars will be priced accordingly.

600 Electrical

**1 AMT AGET-600-17-MVP
-5K-48V**



Transit Lithium 48V-5KW System

Tackle anti-Idling laws and save 60% on fuel and PM costs with our new industry dominating MVP-E System

The MVP-E System is an innovative power system offering near perpetual power. It is equipped with advanced LiFePO4 Lithium Batteries.

The heart of our MVP-E ONLINE POWER SYSTEM is our proprietary, inverter based UPS system and custom software which provides FULL-TIME protection from unexpected power surges and disruptions. Combined with advanced LiFePO4 batteries, the system stores enough power to provide 8-10 hours of continuous power for broadcast equipment and HVAC with the engine OFF!

The system consists of:

- (1) Victron Quattro 5000W Inverter
- (1) Digital Multi Control

** Lithium Batteries (Separate Line Item)*



For Best Performance, system should be viewed as a “plug in hybrid” and connected to shore power when not in use to fully recharge. This will ensure the maximum run time and extend the life and performance of the batteries.

1 AMT ASU-600-99SUV





Finish Wire Electrical

Finish Wire Electrical

Quantity	Manufacturer	Model	Nomenclature
1	AMT	CSP-600-12-R/W	<p>12V R/W Interior Lighting Upgrades</p> <p><i>Using 9 LEDs, our long-lasting light fixtures emit up to 140 lumens of red/white light. Dimmer Included.</i></p>
			
1	EG4	1511092	<p>14.3Kwh 48V Power Wall</p> <p><i>This battery provides 14.3 kWh of storage capacity for indoor applications and a maximum continuous output of 200A. The battery's integrated self-heating feature makes it an excellent option for unheated indoor environments and its LCD screen allows you to easily monitor and control the battery.</i></p> <p><i>With features like a built-in 200A BMS, integrated 600A busbars, E-Stop (Emergency Stop) rapid shut down (RSD) functionality, and dual fire arrestors, the Power Wall Battery ensures that your system will be safe.</i></p> <p><i>Backed by a 10-year warranty and designed for over 8000 cycles at 80% DoD, this battery is an excellent solution for your mobile command needs.</i></p>
			

S01-RF Equipment

1	Star-Mount Systems	SL-GEN3-QRM	<p>Quick Release Mount</p> <p><i>Starlink Performance Gen 3 Hybrid Attachment and Quick Release Color Black</i></p>
			
1	Starlink	GEN 3 WI-FI ROUTER KIT	<p>Gen 3 High Performance WiFi Router-Kit</p> <p><i>Contains Starlink Gen 3 Wi-Fi mesh router and wall mount.</i></p>
			
1	Starlink	Performance Gen 3 Vehicle Mount Starlink Terminal Kit	<p><i>Kit Includes Performance Gen 3 antenna, wedge mount and Advanced power supply.</i></p>
			

Quantity	Manufacturer	Model	Nomenclature
----------	--------------	-------	--------------

S05-Communications

1	JPS	ACU-Z1	MODULAR RADIO INTEROPERABILITY GATEWAY <i>Bundle Includes:</i>
---	-----	--------	--



ACUZ1 Chassis
 VIM-Z1 (12)
 Radio Interface Cables (12)
 Mounting Hardware Incl.

10	Parsec	RBDM-155/490/758 -17-S-B	Low profile Tri-Band Antenna <i>The RFMAX low profile antenna # RBDM-155/490/758-17-S-B is the first of it's kind! A true "low-profile" roof mounted antenna with Tri-band capability to support VHF, UHF and 700/800 Mhz P25 radio communication. This antenna was specifically designed to work with the Motorola APX8500™ All-Band P25 mobile police radio. It's also fully compatible with the L3-Harris Unity XG-100M™.</i>
----	--------	-----------------------------	--



- <4 inches tall. 8 inches long. 3.5 inches wide.
- VHF: 153-157 MHz
- UHF: 470-510 MHz
- P25: 750-870 MHz
- 100 Watts Max Power

1	Peake	260062	911 Emergency Connectivity <i>Bundle Includes:</i>
---	-------	--------	--



Ubiquiti Network and VoIP Bundle Includes:
 (1) Dream Machine Pro Max Router,
 (1) Standard 48 POE Switch,
 (4) Phone Touch Max phones,
 Wireless Access Point,
 Patch Cable and Ethernet Cables





Ubiquiti Installation & Setup

S08-Video





4	Beetronics	17HD7M	17 Inch Monitor Metal 1920 x 1080 resolution (Full HD) Input: HDMI, VGA, CVBS, RCA Mounting: Flush, embedded, wall, desktop External dimensions: 16.6 x 10.2 x 1.5 inches
---	------------	--------	--



1

Quantity	Manufacturer	Model	Nomenclature
	Elo	5501LT	55" Interactive Digital Smartboard Display <i>Elo Touch 5501LT 55" Interactive Digital Signage Display</i>
			
1	elo	E792849	Compute Engine for Elo Smartboard <i>Backpack 4 (Value)</i> <i>Android 12 OS</i> <i>RK3399 Processor</i> <i>4GB LPDDR 4 Memory (RAM)</i> <i>32GB of Storage</i> <i>802.11a/b/g/n/ac + Bluetooth 5.0</i> <i>HDMI</i> <i>4x USB 3.0 support</i> <i>USB-C Output</i> <i>Micro SD Slot</i> <i>GPIO</i> <i>Ethernet 1x LAN (Gigabit)</i> <i>DC inE</i>
			
1	iView	3500STB III	ATSC Digital Converter Box with Recording and Media Player <i>About this item</i> <i>[DIGITAL CONVERTER BOX] The digital TV converter box, converts digital air channels to your analog TVs. Allow you to watch TV channels on your analog TV or computer monitor.</i> <i>[ATSC BOX] The tuner box is programmed to receive local over-the-air (OTA) channels through ATSC signals for you to watch local channels immediately available in your area</i> <i>[CLEARQAM COMPATIBLE] This converter box supports ClearQAM and can be used with a cable provider to watch unscrambled cable channels</i> <i>[TV RECORDING] iView-3500STBIII digital converter box with clock function supports TV recording function. You may record TV programs for future watch</i> <i>[UNIVERSAL MEDIA PLAYER] This digital converter box is also a media player. You may save your media files in the USB drive and play videos, music, and watch photos via the converter box's USB port. Supports up to 4TB portable hard drive.</i>
			
3	Ocean Matrix	OMX-13MHM0002	4 x 1 Multi-Viewer with IR Control <i>Maximize fly-pack footprint and minimize monitoring needs with the 13MHM0002 Ocean Matrix 4K HDMI 4 x 1 Multi-Viewer with IR Control. The unit sets up your display with up to 4 HDMI feeds making it an ideal fit for directing live productions. The 13MHM0002 supports 4K HDMI video signals which can be configured in twelve different possible screen setups. This includes a straight selection of single screen inputs of your 1-4 sources and branching out to a</i>
			

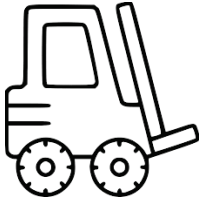
Quantity	Manufacturer	Model	Nomenclature
2	Peerless	ST630	<p>variety of quad screen modes.</p> <p>4 Channels of HDMI Signals IR Sensor for Remote Control Video Resolution up to 4K@30Hz Audio and Mode Switch Buttons Power and Input LED Indicators Black Powder-Coated Steel Cabinet HDCP 1.4 Compliant FCC, CE Certified</p> <p>Mount, Monitor, Tilting, VESA 75-100</p> <p>Mount is an ultra-slim wall mount designed to work with virtually any flat-panel display. This unit mounts almost flush to the wall, leaving the mount itself virtually hidden after installation is complete. VESA 75-100</p>
2	Samsung	UN43LS03NAFXZA	<p>4K LED TV 43"</p> <p>The Frame includes the One Connect box, which will accept the inputs from all your devices, such as cable/satellite boxes and Blu-ray/DVD players, and connects to the TV with a single cable for a streamlined installation. The One Connect box has four HDMI inputs and three USB ports. Integrated Wi-Fi and Ethernet connectivity provide access to the Internet to download apps, and a full web browser is also onboard.</p>
1	SkyVu	C-NXG DS-1000 NIT	<p>32" SKYVUE OUTDOOR TV</p> <p>SkyVue LED Outdoor TVs has a brand new 1000 NIT all weather television, The Brightest NXG Outdoor TV that we offer! This TV is 2x Brighter than the competition and has Superior Performance in Direct Sun making it perfect for boats and pools. Stacked with the absolute latest in digital technology, SkyVue is proud to offer you a full 1080p HDTV built right here in the USA. Order yours direct from the manufacturer today.</p>
1	Winegard	AR-360B	<p>Air 360+ TV Antenna</p> <p>The AIR 360+ revolutionizes the omnidirectional field by providing powerful performance in an easy-to-install design with 360° signal reception. Out of the box, the AIR 360+ can receive VHF/UHF/FM frequencies while parked. Upgrade this Internet ready device with the Winegard Gateway for 4G LTE & Wi-Fi capabilities. The AIR 360+ is an all-in-one solution for your Internet, TV, and FM signal needs! With no hand cranking or aiming, the AIR 360+ antenna is always ready for viewing, listening, and Internet access!</p>

Quantity	Manufacturer	Model	Nomenclature
S13-Panels			
1	AMT	EP	<p>Exterior Panel</p> <p>A connector panel face will be punched and loaded with connectors. Each Panel is custom engineered to your specific needs. The panels are etched and lighted with LED Fixtures.</p>
			
6	AMT	IP	<p>Interior Panel</p> <p>An etched connector panel will be punched and loaded with connectors. Each Panel is custom engineered to your specific needs.</p>
			
S15-Misc			
1	AMT	AMT-Removal	<p>Remove Existing Equipment</p> <p>Remove Existing Equipment to allow for installation of new equipment in racks.</p>
			
1	AMT	CTR-300-99	<p>Fabrication Consumables</p> <p>Misc shop supplies and consumables</p>
			
1	AMT	FMAMT Testing Procedure	<p>Documentation and Testing Procedure</p> <p>Complete manual set, including the following (as applicable):</p> <ul style="list-style-type: none"> -As-built specifications with interior and exterior drawings as used for production of the vehicle. -Chassis and body owner's manuals. -12Vdc and 120Vac legends showing wire gauge, color, number and function. -12Vdc high current wiring diagram illustrating the battery system, isolators, power converters, alternator, disconnect switches and control panels. -Roof top antenna placement drawing and legend identifying antenna placements and termination points. -Audio/Video cabling diagram. -Chassis and generator maintenance manuals -All individual component manuals and warranty registration cards as provided by component manufacturers. Customer is responsible
			

Quantity	Manufacturer	Model	Nomenclature
			<p>for completing warranty cards and mailing them to manufacturers.</p> <p><i>TRAINING. AMT will provide up to one day of orientation on all systems including:</i></p> <ul style="list-style-type: none"> -Power-Up, start up and shut down procedure -Leveling system operation -AC and DC electrical systems operation -HVAC systems operation -Audio/Video system operation and line by line operational check. -Awning operation <p><i>Vehicle documents will be bound and include</i></p> <ul style="list-style-type: none"> -Certified Weight Slip -Power Test Load Verifications -Completed QC Report -Mast Pressure Verification Sheets -Owners Manuals printed and electronic -Electrical and system schematics printed and electronic

S17 Weather System

1 Columbia Weather Systems 9545-BNDL



Magellan MX600 Weather Station w/Rain Fall

Especially ideal for mobile applications

GMX600 Transmitter

Sensors include:

- Ultrasonic Wind Direction Sensor*
- Ultrasonic Wind Speed Sensor*
- Temperature*
- Relative Humidity*
- Barometric Pressure*
- Rainfall*
- Built-in Electronics Compass*
- Built-in GPS*
- Weather Display Console*

Weather Display Console:

- Touch Screen LCD Color Display Console*
- Desktop Chassis*
- Displays real-time weather readings*
- Weather MicroServer*

Quantity	Manufacturer	Model	Nomenclature
----------	--------------	-------	--------------

S20-Installation Materials

1 AMT

Misc



Misc. Cables and Integration Supplies.

Your base-band and RF system will be fully engineered and integrated into the truck. Price includes all cables, connectors and integration supplies including rear rack supports. Following integration the system will be completely tested and documentation as-built drawings will be generated and provided in hard copy as well as electronically. NOTE: Customer furnished equipment must be shipped complete with all specific connectors and cables as well as rack mount kits. AMT can provide these items but they may incur extra cost.

S21-Network

1 Cradlepoint

R1900



R1900 5G/Cat 20 LTE Router

The R1900 mobile router includes an embedded Firstnet-ready 5G modem that can automatically connect to Cat 20 LTE if the vehicle moves outside of 5G coverage. In addition, the R1900 is designed to accept the RX30 managed accessories which provide either four additional GbE PoE ports or four additional GbE ports and a second modular modem.

S22-Drone

1 AMT

CFE Drone Prep

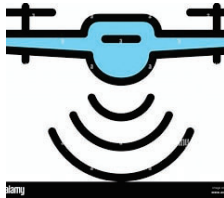

Install CFE Drone Detection System

Mount and install Customer Furnished remote antennas for drone flight station and/or detection system

S23-Control Systems

1 Extron

60-1497-21



16x16 4K HDMI 2.0 Matrix Switcher

The Extron DXP HD 4K PLUS Series are high-performance HDMI matrix switchers for computer and video signals at resolutions up to 4K/60 with 4:4:4 color sampling. They support HDMI 2.0b specifications, including data rates up to 18 Gbps, HDR, Deep Color up to 12-bit, 3D, HD lossless audio formats, and CEC. These HDCP 2.3-compliant matrix switchers incorporate Extron technologies such as SpeedSwitch®, EDID Minder®, and Key Minder®, as well as HDMI input equalization and output regeneration, to ensure reliable system operation. Digital audio can be de-embedded from any input and assigned to digital or analog stereo outputs for easy integration. Available in fixed configurations from 4x2 to 16x16, the DXP HD 4K PLUS Series is ideal for applications that require reliable, high performance matrix switching of 4K/60 HDMI video and audio signals.

2 Extron

60-593-02

Low Profile AV Connectivity Mounting Frame

Quantity Manufacturer Model



Nomenclature

The Extron AAP 100 is an AAP™ AV connectivity mounting frame with a compact, low-profile design. No junction box is required; the AAP 100 can be mounted directly to a table, lectern, or other flat surface. It can accommodate up to two single-space AAP modules. This mounting frame is available in black or white. AAP modules are sold separately. Dimensions: 1.75" x 4.5" x 0.1" (4.5 x 11.4 x 0.25 cm)

2 Extron 70-1219-02



(2) HDMI Female to Female on 10" Pigtails

Extron AAP™ AV Connectivity Modules feature pass-through AV connectors or active modules on mountable metal plates that fit into select Extron interfaces, AAP AV connectivity mounting frames and other products that accept AAP modules.

1 Extron 70-2557



7" Pro Touchpanel

The Extron TLP Pro 725T is a 7" Tabletop TouchLink® Pro Touchpanel with many enhanced features. Extron redesigned this latest TouchLink Pro Touchpanel inside and out with a new, high-performance quad-core processor, eight times more memory, a higher resolution, 1024x600 capacitive touchscreen built with scratch and smudge-resistant Corning® Gorilla Glass®, and a distinctive enclosure with a sleek, gracefully-sweeping back. The TLP Pro 725T also features the convenience of PoE - Power over Ethernet, which allows it to receive power and communication over a single Ethernet cable. It is ideal for any environment requiring a stylish, tabletop touchpanel with a fully-customizable interface.

The TLP Pro 725T works with any Extron control processor and HC 400 Series system and is designed for use in AV system applications that require complete, interactive control of a broad range of source devices. TouchLink Pro touchpanels operate using standard network infrastructure and are easy to install with reliable and cost effective Ethernet cable.

All TouchLink Pro touchpanels can be customized using Extron GUI Designer software. This powerful interface design software offers ready-to-use templates for a wide variety of rooms and presentation environments. These designs may be used as is, or customized for the application by simply changing individual graphic elements.

2 Extron 70-491-15



(2) RJ-45 Female to Punch Down for CAT 6

Extron AAP™ AV Connectivity Modules feature pass-through AV connectors or active modules on mountable metal plates that fit into select Extron interfaces, AAP AV connectivity mounting frames and other products that accept AAP modules.

1 Extron 79-2577-01



LinkLicense for TLP Ctl Processor

TLP Control Processor Upgrade

Quantity Manufacturer Model Nomenclature



S25-Computer

1 Dell

**OptiPlex 5070
Micro Kit**

Dell OptiPlex 5070 Micro



*Intel® Core™ i7-9700T (8 Cores/12MB/8T/2.0GHz to 4.3GHz/35W);
supports Windows 10/Linux
Windows 10 Pro 64bit English, French, Spanish
8GB 1X8GB 2666MHz DDR4 Memory
M.2 256GB PCIe NVMe Class 40 Solid State Drive
24" Monitor P2418D*

S28-Surveillance System

1 Axis

01841-001

Q8752-E Bispectral PTZ Camera



Ideal for perimeter surveillance and border control, AXIS Q8752-E offers reliable thermal detection and visual identification with x32 integrated optical zoom in one bispectral camera. AXIS Q8752-E Zoom delivers 3x thermal zoom allowing you to detect a human as far as 3 km (3342 yards) according to Johnson's criteria. 35 mm thermal model is also available. It features Electronic Image Stabilization (EIS) on both channels and smooth PTZ operation.

1 Axis

02403-004

S2108 8 Camera NVR (2TB)



AXIS S2108 includes all the components you need for basic surveillance. All hardware is validated to run AXIS Camera Station, so you'll enjoy all the benefits of this compact, easy-to-use solution. For instance, thanks to its intuitive interface, anyone can easily manage the system, handle incidents, and quickly export evidence. Designed to fit almost everywhere, AXIS S2108 is one of the most compact all-in-one recorders on the market. This affordable, all-in-one solution supports devices up to class 4 but is optimized for connecting 8 PoE class 3 devices. And, because our cameras feature Axis Zipstream to significantly lower bandwidth and storage requirements, there's minimal storage needed.

4 Axis

02416-001

P4707-PLVE 2 Sensor 5MP Camera



AXIS P4707-PLVE includes 360° IR illumination with individually controllable LEDs so you'll enjoy clear images even in low light or complete darkness as well as undistorted colors during the day. Featuring AXIS Lightfinder you get color images recorded in near darkness. And Forensic WDR ensures clarity when there's both dark and light areas in the scene. It offers two 5 MP channels and a frame rate of 30 fps letting you capture both wide angle and zoomed-in, detailed views. And, thanks to 2.5x zoom it delivers wide views and you can zoom in for all the details. Furthermore, audio input allows you to listen in to transactions or incidents.

Quantity	Manufacturer	Model	Nomenclature
1	Axis	02475-001	<p>Axis TU9002</p> <p><i>Featuring two-in-one functionality, the TU9002 Joystick from Axis Communications can be used as a joystick or jog dial. This 3-axis joystick is equipped with a turn knob and eight application-defined hotkeys for responsive and accurate control of Axis PTZ cameras. In addition, the toggle key enables you to switch between different applications.</i></p>



S37 Airtime Services

1	Peake	260062-Service	<p>Annual Service 3 year service plan <i>Tactical Voice Premium</i> <i>Premium TacticalVoice SIP Line Unlimited Minutes and CIR</i></p> <p>PROSupport Level 3 Annual Plan <i>Annual Plan PEAKE Level 3 PRO Support Service</i> <i>-24/7 NOC Connectivity Support</i> <i>- Modem Spare in the Air</i> <i>- Advanced Engineering Support on all Network Configurations</i> <i>- Annual CyberSecurity Assessment Service</i></p>
---	-------	----------------	--



36	Starlink	PRIORITY - 40GB	<p>Starlink Service 3 year <i>Unlimited Standard Data</i> <i>Public IP</i> <i>Network Priority</i> <i>Priority Support</i></p> <p><i>Unlimited Standard Data after Priority allotment. Additional Priority Data available by the GB.</i></p>
----	----------	-----------------	---

